

MAXIMUM PRODUCT QUALITY AND PRODUCTION RELIABILITY

DISCOVER OUR SHEET EXTRUSION
LINES

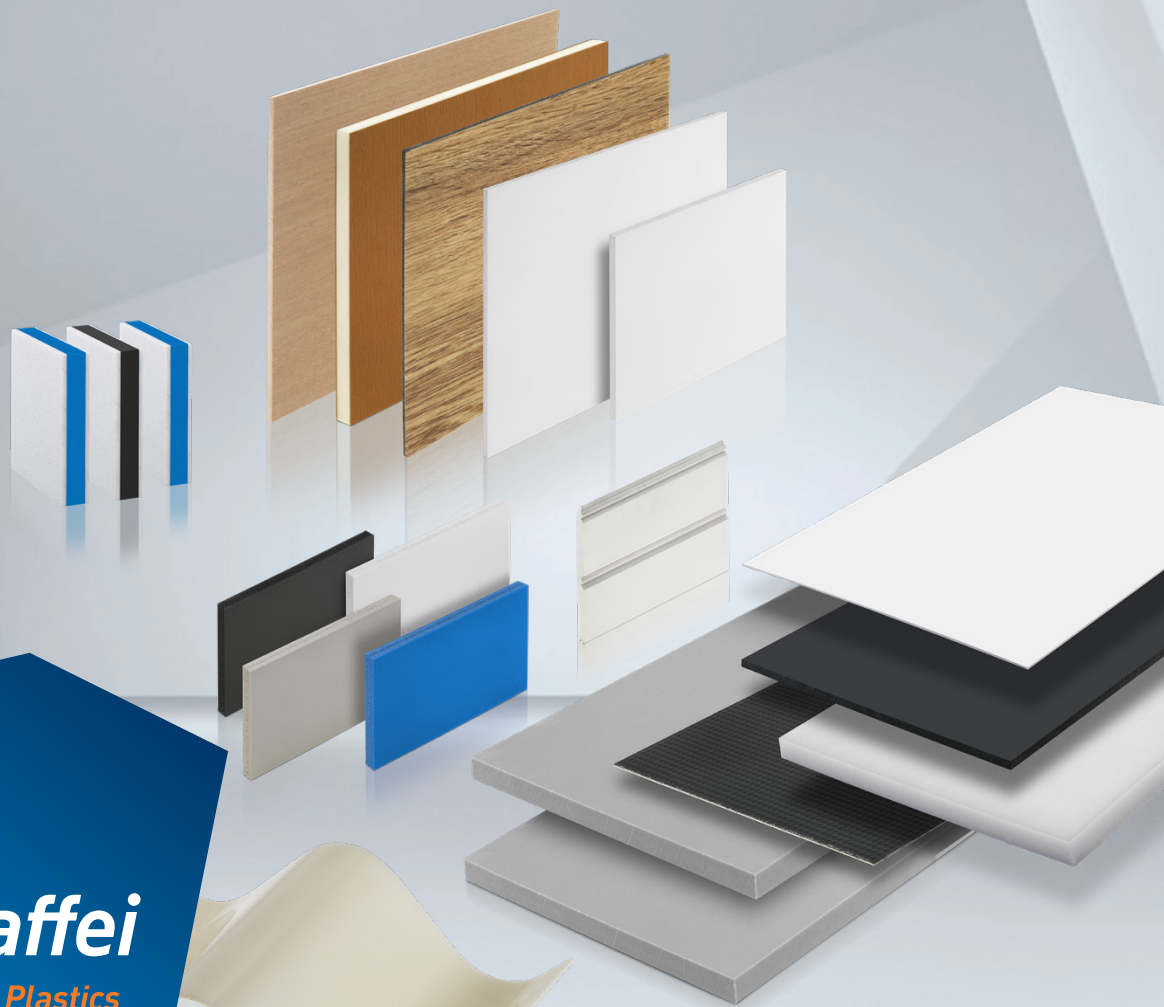

KraussMaffei
Pioneering Plastics

PROCESSES

EXTRUSION



Single-screw extruders



Co-rotating twin-screw extruders (ZE series)

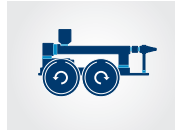

Counter-rotating, parallel twin-screw extruders (KMD series)

LAMINATION/ CALIBRATION



Vertically



Horizontally



J-type



PlanetCalendar with flexible roll arrangement

FINISHING



Winding



Cutting and stacking



Measuring and controlling



Printing and coating

CHALLENGES FOR SHEET EXTRUSION LINES **RELIABILITY AND EFFICIENCY FOR THE BEST RESULTS**

Manufacturing sheets with high capacities, in high quality, being flexible in processed polymers, with the desired properties – and not only fast but also cost-efficiently: all this calls for state-of-the-art production solutions. Welcome to KraussMaffei.

Now even easier

One contact for everything, from the raw material through to finished product.

Now even more cost-effective

Compound and shape plastic formulations in a single pass, achieving higher throughput and increasing efficiency.

Now even higher quality

Continuously achieve the highest quality using reliable twin-screw extruders as well as innovative system concepts.



*Integrated process solutions
from a single source are
the focus of the planning
and design engineering of
KraussMaffei sheet systems.*

Higher quality, more production reliability, increased cost-efficiency

All for more competitiveness

Secure your competitive edge. Using customized production technology by KraussMaffei you produce premium quality plastic sheets – more easily and with more cost-efficiency than ever.

Besides systems with single-screw extruders, KraussMaffei also provides extrusion lines with twin-screw extruders for in-line compounding, specifically for processing formulations with larger concentration or loadings of additives. Here, the compounding process is integrated into the production of sheets.

For premium quality, rigid (PVC) sheets, excellent melt homogeneity is the foremost requirement. The homogeneity is achieved with the counter-rotating 32D twin-screw extruder by various measures. In the machine control system, all critical process parameters are monitored, documented and adjusted if required. The processor continuously has an overview of the systems, an indispensable factor for production with quality assurance.

Optimal system concepts for your product – your advantages

- No need to wait for the ready made compound. Thus, more flexibility and the option to start production on short notice, especially with non-standard formulations
- High throughput
- Lower operating costs thanks to lower consumption of energy and utilities and less efforts for logistics, especially in the case of in-line compounding
- Use of more cost-effective raw materials instead of finished compounds
- Larger selection of potential suppliers of raw materials
- Lower capital investment for materials
- Lower raw material costs thanks to complete re-processing of startup material, edge strips and scrap
- Lower production costs

In-depth process understanding

Our focus is on the processes in which our machines form the core of the system and for which we are able to provide expertise from the raw material through to the finished product in a start-to-end solution. Consequently, we are optimally equipped for projects of any scope, from an individual machine though to a turnkey system. We ensure high reliability of our systems by:

- Innovative technical solutions for the respective tasks
- Extensive engineering resources
- Experienced project management
- State-of-the-art project control tools
- Qualified suppliers and partners

We are your system partner

From advice on the optimization of the procedure and the production process through to the installation and system startup, commissioning and process optimization – KraussMaffei is your system partner in all project phases:

- Extrusion line design
- Raw material handling
- Utility calculation
- Interface coordination with third parties
- Project management
- Training, production support and servicing

Highest precision is required

As designer and manufacturer of all core components, KraussMaffei is your highly skilled partner. Our engineers ensure that your sheet extrusion lines are functioning with high precision and reliability. Our extrusion lines meet the utmost demands regarding stability and accuracy throughout the entire production process.

THE BENEFITS:

- Customized production technology
- High stability and accuracy throughout the entire production process

OUR SOLUTIONS ENABLE A WIDE RANGE OF APPLICATIONS



Insulation board

Material: XPS
Technology:
foam extrusion lines



Fiber composite and fiber-filled sheets

Material: formulations and
compounds based on a
fiber-reinforced hybrid material.
Technology: 32D twin-screw
extruder with premium-quality
wear resistance

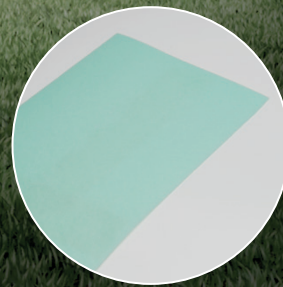

Impact sound insulation

Material: polyethylene
Technology: foam extrusion lines

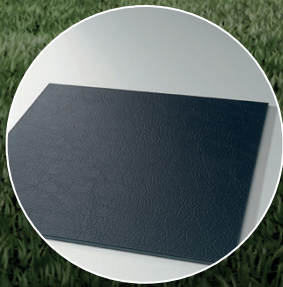

Sheet for vehicle interiors

Material: TPO
Technology: in-line
extrusion lines

**Optical sheet
and safety glass**

Material: PC, PMMA, PVB

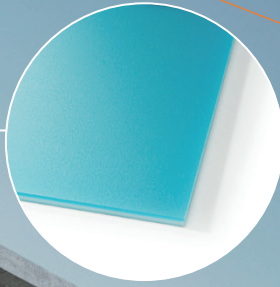

Roofing membranes

Material: TPO or PVC
Technology: extrusion
lamination systems

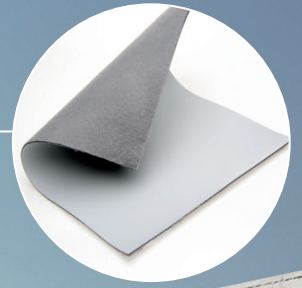

**Advertising banners,
wall panels (furniture)**

Material: PVC sheets, compact,
foamed or coextruded
Technology: 32D twin-screw
extruder

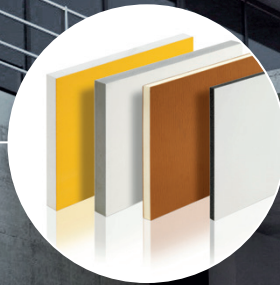

Floor coverings

Material: PVC & PO, highly filled core layers
Technology: in-line extrusion lines

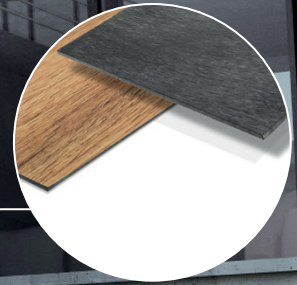

Furniture, interiors

Material: PVC, polypropylene
Technology: 32D twin-screw
extruder

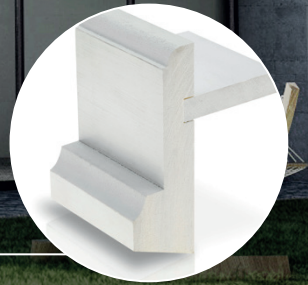

**Liners for swimming pools
or ponds**

Material: PVC, PO
Technology: sheet extrusion & lamination

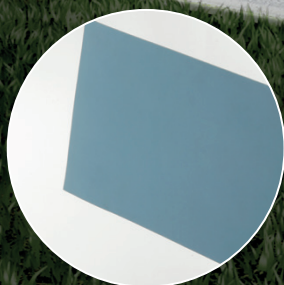

We are your system provider for integrated solutions

Here is how you profit from sheets of polyolefins and elastomer compounds

Reducing the use of raw materials and integrating multiple working steps means saving money. Make use of all your resources in manufacturing sheets of polyolefins.

Chemically foamed sheets

The 36D single-screw extruders are optimally suited for extrusion of foamed PO sheets. The surface of the sheets is closed-cell, whereas the inner core cross-section has a uniform cell-shaped structure. The foaming process is triggered by chemical blowing agents under application of temperature and pressure. The interaction of formulations, melting processes, and the special geometry of the contours of the lips of the flat sheet die make it possible to produce sheets with significantly reduced density and, consequently, reduced use of raw materials. Ideal prerequisites for the construction of containers for water and acids, for example.

In the in-line process for manufacturing chemically foamed sheets, the two separate working steps, compounding and extrusion, are combined into an integrated solution. In-line compounding enhances cost-efficiency and quality. The twin-screw extruder makes it possible to mix the polymer with the blowing agent and other additives and to extrude a compact sheet in a single pass. The process prepares the material more gently and with greater cost-efficiency.

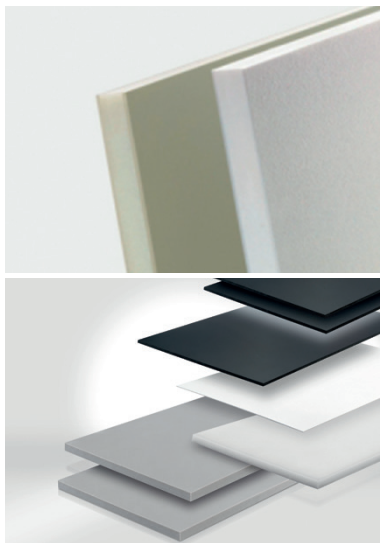

Your products by KraussMaffei

Chemically foamed sheets

Material

- HDPE, PP, with addition of suitable blowing agents, coordinated with customer requirement

Technology

- Extrusion using 36D single-screw extruder
- With melt pump depending on requirement
- Specially designed flat sheet die
- 3-roll polishing calender

BENEFITS FOR CUSTOMERS:

- Reduction of materials costs due to lower density
- Gentle melt processing using 36D single-screw technology
- Optimal melt homogeneity and foam structure
- Closed cells
- High output

Your products by KraussMaffei

Geo-membranes

Material

- TPO & PVC, with and without fabric reinforcement

Technology

- Single-layer and multilayer extrusion
- Lamination with in-line compounding

Automotive sheets

Material

- TPO, PVC

Technology

- Monolayer extrusion
- Molding
- Laminating and/or coating

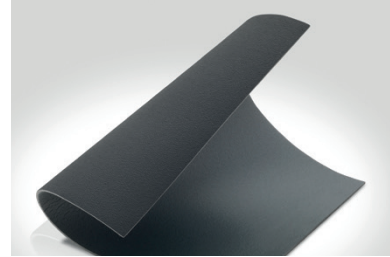

BENEFITS GEO-MEMBRANES:

- Use of cost-effective raw materials
- Reincorporation of edge strips and scrap webs
- High filler content
- Sheet widths up to 8,000 mm

Customizing almost without limits

Sheets are an essential component in the design of interiors. This applies to vehicles (door inner panels, instrument panels, seats) and to the residential area (furniture, paneling of walls and objects). Depending on configuration and requirement, sheets of one or multiple layers can be manufactured in the extrusion process and in-line improved by embossing or laminating (e.g. with a foam back).

Cost-effective systems for the manufacturing of geo-membranes

Extrusion lines for lamination by KraussMaffei are proving their quality every day in the production of geo-membranes. The extrusion lines can be designed for sheets of one or multiple layers, with and without fabric reinforcement, and thus always provide the opti-

mal cost-effective solution for your sheet manufacturing. In particular, using the modularly designed twin-screw extruders, sheets can be produced reliably and with the highest quality immediately from recyclates with and without filler. In this, a filler content up to 80% and in-line blending of polymers are possible. In combination with the KraussMaffei single-screw extruders, colored outer layers or weldable and sealable layers can be manufactured. Systems for sheets with thicknesses from 0.1 to 6 mm and widths from 2 to 7.5 m at a throughput of up to 6 t/h have been completed.

BENEFITS AUTOMOTIVE SHEETS:

- Lower costs of raw material and energy
- High filler content
- Sheet widths up to 2,100 mm and more
- System design optimized for quick raw material/color change

Perfectly combined process steps

Compounding and shaping of sheets of flexible PVC or modified polyolefins

Your production department can look forward to significant cost advantages – our systems make it possible to manufacture sheets of premium quality for the most diverse tasks. In addition, the otherwise separate process steps of compounding and sheet extrusion are consolidated in one continuous process.

Highest flexibility and cost-efficiency

In manufacturing roofing sheets, highest flexibility is required: variable arrangements of the layer thicknesses on the upper and lower layer of the sheet, various reinforcements, fleece-back, different color shades, fillers and flame retardants, short rolls for retail, jumbo rolls for finishers. For all these requirements, KraussMaffei provides customized concepts. Whether it is a system for smaller throughput with one polishing calender or a highly automated solution with two polishing calenders, the focus is always on cost-

efficiency and quality. Using KraussMaffei twin-screw extruders, quick conversion of a system from PVC processing to TPO processing is also possible.

Compounding and engineering

For manufacturing floorings, KraussMaffei provides an economical system concept combining compounding and sheet manufacturing in one heat. Designed specifically for filling the thermally sensitive material PVC with 60 to 70% mineral filler, these systems provide you with unbeatable productivity. On request, our engineering

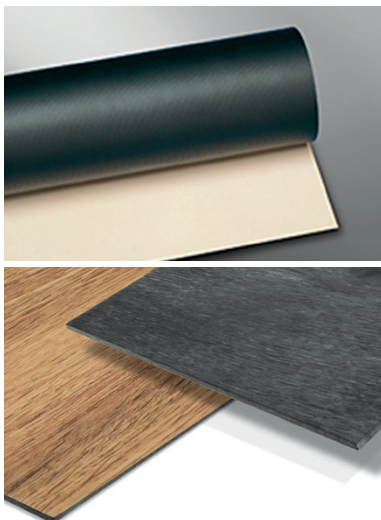

Your products by KraussMaffei

Roofing membranes

Material
– PVC, TPO, with or without fabric reinforcement

Technology
– Lamination system for double-sided fabric embedding with in-line compounding
– Counter-rotating and co-rotating twin-screw extruders for processing and extruding the compound

Floor coverings

Material
– PVC, filled with 60 to 70% mineral additives, PE

Technology
– Counter-rotating and co-rotating twin-screw extruders for processing and extruding the compound
– In-line laminating station for decorated sheet and surface protection
– Cutting and shaping equipment

BENEFITS ROOFING MEMBRANES:

- Lower costs for raw material and energy
- High filler content
- Sheet widths up to 3.6 m
- System design optimized for processing and energy use

BENEFITS FLOOR COVERINGS:

- High filler content
- Sheet widths up to 3.6 m
- System design optimized for processing and energy use

Your products by KraussMaffei

Truck tarps/advertising banners

Material

- PVC, PE, fabric reinforcement

Technology

- Counter- and co-rotating twin-screw extruders for processing and extruding the compound
- In-line laminating station for coating the fabric

Sheets of natural fiber material

Material

- WPC (wood plastics composites), composite material of renewable resources and polymers (HDPE, PP or PVC)

Technology

- Co-rotating twin-screw extruders for cost-effective processing of a compound
- Counter-rotating twin-screw extruders of the 32D series for processing and extruding the compound

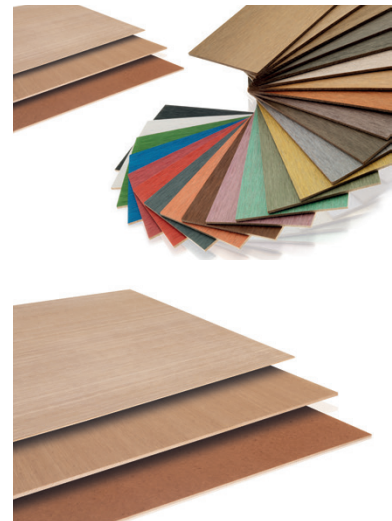

team will integrate the extrusion line into an existing production system for floor coverings. Leave the coordination of interfaces to our experts and concentrate on the design of your product.

Specialized in processing natural fiber-reinforced materials

KraussMaffei covers the entire value chain for composite materials with its portfolio in co-rotation and counter-rotating extrusion technology.

Beginning with the selection of the suitable raw material by way of the formulation, material processing and pelletizing through to extrusion and manufacturing complete application systems, we fulfill the individual requirements of our customers as their system partner.

Processing natural fiber-reinforced and filled plastics requires special machine technology, a high measure of expertise in process technology, and active wear resistance for the process unit. KraussMaffei has aligned its machine design with these demands consistently. For instance, a specific metering unit ensures consistent material feed. The specially designed degassing zone of our 32D twin-screw extruders ensures that residual

moisture can escape. A high installed screw torque paired with an internal screw heat-balancing unit and a screw geometry modified specifically for natural fiber compounds guarantees a uniform melt and consequently provides a finished product of premium quality. In addition, at KraussMaffei, the screws are armored with highly wear-resistant coating beyond industry standards, and the barrels are equally coated with premium-quality material. This combination provides the process unit with optimal protection against wear by corrosion and adhesion.

Truck tarps and advertising banners

For manufacturing truck tarps and advertising banners using flexible PVC or PE, the sheet extrusion lines by KraussMaffei are the ideal machines. Thanks to their reliable extrusion and polishing calender technology, they provide production reliability as well as high sheet quality and thus investment security.

Outstanding energy efficiency and higher flexibility make the extrusion lines a cost-effective solution. Perfectly coordinated peripheral devices upstream and downstream are specifically tuned to the requirement and function with high efficiency.

BENEFITS SHEETS OF NATURAL FIBER MATERIAL:

- Energy-efficient production
- Active wear resistance
- High flexibility in processing various formulations

BENEFITS TRUCK TARPS / ADVERTISING BANNERS:

- Without solvent
- System design optimized for processing and energy use
- Sheet widths up to 3.6 m

Large portfolio for individualized applications

Cost-effective production of rigid PVC sheets

Rigid PVC sheets – compact, foamed or coextruded – are a contemporary alternative to wood, fiberboards, and other compact materials. They can be further processed or refined in many ways, and they are applied in many areas of the construction and advertising industries.

KraussMaffei, as a highly skilled system provider, for years has offered many proven, integrated system concepts for a variety of PVC sheet products.

For this, the 32D twin-screw extruder series has been used. The product portfolio includes the models of the KMD 90-32/PL through to the KMD 184-32/PL – both for the production of foam sheets and of thermoformable, premium-quality compact sheets.

Advanced process technology expertise for perfect product quality

By means of its optimized screw geometry, the 32D process unit grants, in addition to high output and a wide processing window, optimal melt homogeneity. The screws are armored with molybdenum by default, chrome-plated and externally heat-balanced.

Complete system concepts for the cost-effective production of PVC sheets

To be capable of producing premium-quality sheets, both experience in extrusion technology and expertise are necessary. Our concept includes a list of major advantages, for example for integral foam extrusion: high output, delivery of the entire system from a single source. All engineering work is carried out by an experienced team of experts.

Systems for corrugated sheets

Manufacturing corrugated sheets is a special application of PVC sheet extrusion. For various corrugated sheets, KraussMaffei provides cost-optimized individual solutions, such as transparent or coextruded versions.



Your products by KraussMaffei

Partitions, facade construction, advertising billboards

Material
– PVC

Technology
– 32D twin-screw extruder
– Complete sheet lines coordinated with the raw material

PVC corrugated sheets

Material
– PVC
– With molded-in color or transparent
– Coextruded, with outer layer that can be colored

Technology
– Extrusion using 32D twin screw
– Mono compact line for classic sine-wave sheet or customer-specific sine design
– Coex line for classic sine-wave sheet or customer-specific sine design
– Mono or Coex combined line for regular sheet extrusion, can be reconfigured for sine-wave sheet production
– Mono or Coex line for Imperial design



BENEFITS FOR CUSTOMERS:

- Longest possible service life
- Excellent price-performance ratio
- Cost-optimized individual solutions
- Flexible market entry

System solution from a single source

Systems for manufacturing C-PVC sheets

KraussMaffei provides systems for processing C-PVC, a material especially in demand in equipment and system engineering and in the chemical and semiconductor industries due to its higher chemical resistance to acids and bases.

Premium quality wear resistance for C-PVC processing

Besides the optimal design from a process technology standpoint, in C-PVC processing, special attention must be paid to perfect wear resistance. That's why all KraussMaffei machines are equipped with fully chrome-plated screws and adapters. In addition, we use hardened, glossy chrome-plated rolls in the polishing calendar. The screws are molybdenum-welded in standard models, and they operate in a deep-nitrided barrel of high hardness and high hardening depth. To ensure even greater wear resistance, we can optionally provide tungsten-carbide-armored screws and bi-metal barrels for the parallel twin-screw extruders. The service life of these processing units increases by multiple times compared to standard equipment.

Varied applications (C-PVC)

C-PVC sheets are mostly used in areas in which increased requirements for mechanical strength simultaneously coexist with higher thermal stress, for example in sheets for industrial applications, in galvanizing, in container construction, in tanks for acids and bases and in pharmaceutical production installations.

Your products by KraussMaffei

C-PVC sheets for industrial applications and container construction

Material

- C-PVC

Technology

- 32D twin-screw extruder
- Complete sheet lines adapted to the raw material

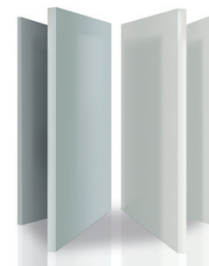
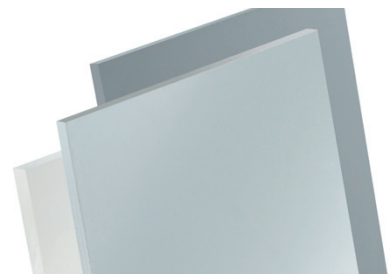

BENEFITS C-PVC SHEETS:

- Optimal process concept
- Special screw geometries
- Perfect wear resistance
- Steady, uniform processing over life time
- Maximum output with homogeneous melt
- Excellent price-performance ratio

Perfect solutions for highest transparency

Engineering polymers

More flexibility for your manufacturing by fast adaptation to the sheet thickness, problem-free changeover and easy operability. All this means higher availability.

Sheet extrusion lines with clear results

In manufacturing crystal-clear plastic sheets, the PlanetCalender by KraussMaffei provides one-of-a-kind flexibility and performance for highest quality and productivity. Its two adjustable rolls enable fast adaptation of the system to the thickness of the respective sheet and thus high machine availability. The central roll can also be replaced conveniently, making a quick changeover from smooth to structured product surfaces possible. From extrusion of the plastic through to stacking the finished sheets, the systems meet all requirements for perfect operability. KraussMaffei meets the individualized requirements and process technology conditions thanks to absolute customer-specific flexibility in planning and designing systems. Well-founded knowledge about the complete production process makes KraussMaffei a reliable partner for manufacturing transparent sheets.

EVA sheets

High clarity, low shrinking tendency, good homogeneity and, if necessary, double-sided embossing. The performance specifications for the quality of an EVA sheet is defined, as it is used for manufacturing photovoltaic modules or laminated safety glass panels. The EVATE technology by KraussMaffei fulfills these requirements, and in addition, it also has enormous advantages for the sheet manufacturer. The flat sheet extrusion line optimally configured for this application is able to produce, at high speed, sheets more than 3 m net wide, which results in tripling the widths common today. The system's efficiency can be further increased by reprocessing the edge trim without loss of quality. With the new EVATE (pat. pend.) sheet extrusion technology, an exciting solution from an ecological and economical perspective for manufacturing EVA sheets is available now.



Your products by KraussMaffei

EVA and PVB sheets

Material

- EVA sheets for encapsulating photovoltaic modules
- PVB sheets for laminated glass panels

Technology

- Sheet extrusion lines with in-line compounding
- Special cooling equipment

Transparent sheets

Material

- PC, PMMA, PETG, APET

Technology

- Sheet extrusion line with twin-screw extruder and PlanetCalender

BENEFITS EA AND PVB SHEETS:

- Sheet widths over 3 m
- Throughput greater than 1,200 kg/h
- Recycling of the edge trimming
- Twin-screw extruder for the uniform preparation of the plastic
- No premature cross-linking of the material
- Low shrinking tendency of the sheet
- Can be embossed on both sides

BENEFITS TRANSPARENT SHEETS:

- Manufacturing sheets with perfect optical properties
- Sheet thickness up to 20 mm

Your products by KraussMaffei

Rigid packaging sheets

Material

- PET, PS, SAN, ABS, PE, PP

Technology

- Direct extrusion (without pre-drying)
 - Extrusion in one or multiple layers
 - In-Line Compounding of fillers and various additives (e.g. anti-statics, anti-fog, etc.)
-



BENEFITS FOR CUSTOMERS:

- Cost advantages by processing raw materials and recycle
- Processing of PET pellets and recycle without pre-drying



Direct extrusion of PET sheets

While the PlanetCalender can be flexibly and easily configured for the optimal cooling of a sheet depending on material and thickness, the twin-screw extruder from the ZE UT, ZE UTxi or ZE BluePower series takes care of the perfect and improved melt quality of the polymer. Whether it is new A-PET and G-PET material or regrind from bottles and edge trims, the material does not have to be crystallized or pre-dried. Simultaneously, powdered additives for improving the product properties can be added. Even using high proportions of regrind, premium quality, clear sheets can be manufactured. The flexible concept permits the integration of single-screw extruders as coextruders for manufacturing multi-layered sheets with functional layers. The fusion of twin-screw extruder and PlanetCalender leads to cost efficiency and flexibility: Cost efficiency due to energy-saving processing of individual materials and regrind instead of compounds. Flexibility due to wide range of sheet thicknesses or embossings.

Specialists for special tasks

High performance polymers

The KraussMaffei Group offers you comprehensive technologies along the entire value chain for manufacturing fiber-reinforced components.

High performance polymers are particularly suited to medical applications for which biocompatibility of the material are a prerequisite. However, many of these polymers are very corrosive while processed as melt and require high processing temperatures. Take the advantage of KraussMaffei's long time experience in selecting and handling high alloyed steels resistant to temperature and corrosion.

Systems and solutions for fiber-reinforced sheets

Saving weight – an important objective in developing vehicles in general, is the base for lower energy consumption and thus range extension. Thermoplastics based composites score with lower material and processing cost, but easy recycling as well.

The KraussMaffei Group offers you comprehensive technology along the entire value chain for manufactur-

ing fiber-reinforced components. The extrusion of sheets with endless fiber reinforcement, so called UD-sheets, is only one example. Foer unwinding the roving, spreading the fibers and embedding them in the polymer matrix, the engineers of KraussMaffei provide various solutions, in combination with a single- or twin-screw extruder. For efficient processing of the sheets into a finished component KraussMaffei Group companies are able to offer you a wide range of robotics and injection molding systems.

Sandwich panels

Outer layers of fiber-reinforced polymers in combination with a foamed polymer core. Sandwich panels for lightweight design of vehicles, ships or architecture? Start-up your production with our extrusion and engineering know-how.

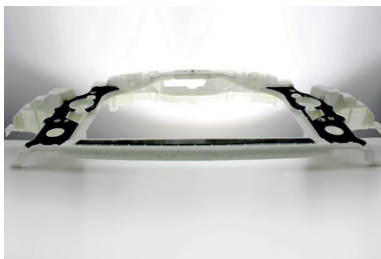

Partially reinforced frontend carrier (source: Fraunhofer IMWS, "Von der Endlosfaser zum konsolidierten Halbzeug" [From continuous fiber to consolidated semifinished product])

Your products by KraussMaffei

High-performance plastics

Material

- PEEK, FEP, PVF, PVDF, PAI, ETFE, PEI
- Sheets for medical technology, electrical and mechanical engineering

Technology

- Co-rotating twin-screw extruder made of special alloyed steels res. metals

Fiberglass-reinforced lightweight construction panels

Material

- PP, PC, PA, PMMA, PEEK, with carbon fiber, natural fiber or fiberglass reinforcement

Technology

- Single-screw extruder or co-rotating twin-screw extruder for plasticizing and dispersing the raw material
- Gentle embedding of the fibers by means of special dies, rolls or presses

BENEFITS FOR CUSTOMERS:

- Excellent mechanical properties
- Significant savings in material costs
- Sheet widths up to 1,200 mm
- Lab equipment for developing new products and applications
- Fiber-friendly processing and high flexibility

A guarantee for sustainable production

Physical foaming

In the construction industry and in the automotive industry, foamed plastic products are produced for the most different applications with individual properties in a cost-effective way.

The range of products is extremely diverse: impact sound insulation and rigid foam sheets for heat insulation for the construction industry. Sandwich-assembly / sandwich panels and compact sheet or foam sheet as decorating sheet in the vehicle interior.

Thanks to process expertise acquired over decades and innovative extrusion technology, sheets for different applications can be manufactured. The systems provide excellent product quality especially for sheets made of PS, PE/PP, TPU whether high or low density.

Precise temperature control

Depending on the polymer and process, the res. boards can have totally different properties. Here in particular, the precise temperature control of our extruders guarantees a high quality standard.

All systems are configured for processing environmentally friendly blowing agents.

Your products by KraussMaffei

Physically foamed sheets and boards

Material

- PS, PE, PP, PET, PEI, PES, physically foamed using environmentally friendly blowing agents

Technology

- Schaum Tandem ZE/KE twin-screw extruder ZE combined with single-screw extruder KE for throughput up to 2,800 kg/h
- Schaumex single-screw extruder KE for throughput up to 320 kg/h

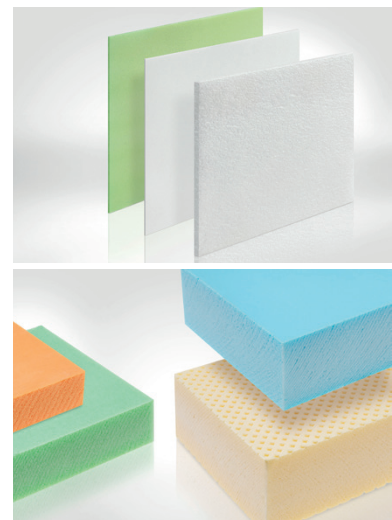

BENEFITS FOR CUSTOMERS:

- Processing environmentally friendly blowing agents
- Recycling startup material, edge strips and scrap webs
- Perfectly engineered system components

INTEGRATION AND FLEXIBILITY SYSTEMS TECHNOLOGY REDEFINED

High product quality can only be guaranteed if processes and technology harmonize perfectly. KraussMaffei contributes excellent expertise, high standards and longtime experience to make extruders and downstream units harmonize with one another optimally for maximum cost-efficiency of your production.





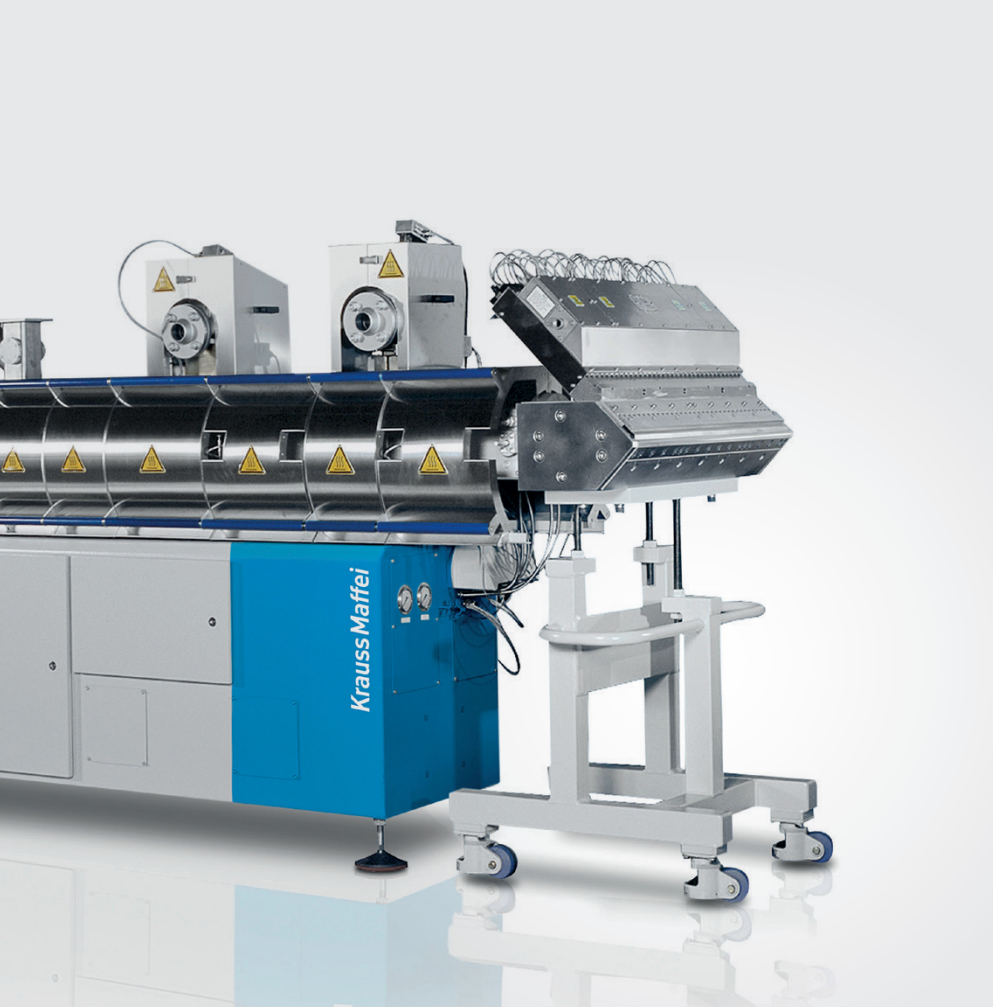

Twin-screw extruders with sheet die

Sheets of polyolefins and engineering thermoplastics

Extruders and downstream units customized

Whether it is an extruder, a polishing calender or a cooling roller track: all components of the extrusion line are consistently coordinated with each other to assure a process flow without a hitch.

The single-screw extruders by KraussMaffei are not only suited to extruding common polyolefins such as HDPE and polypropylene but are also perfect for processing PMMA, PA, ABS, PP, (HI)PS, PET and many other polymers. For processing corrosive, filled, fiber and foamed polymers, the process units of the extrud-

ers are designed with different materials and with special wear resistance. The results of our experience and expertise in designing multi-zone screws, degassing screws or barrier screws are the high quality of your finished products and the cost-efficiency of your production.



Polishing calender technology used in processing polyolefine compounds into sheets



KraussMaffei twin-screw extruder of the 32D series KMD 164-32/PL with die for processing rigid PVC

Twin-screw extruder – compounding instead of extruding only

Design your sheet system with regard to the extruder exactly in the way that is optimal for the product to be manufactured and for the production process. KraussMaffei has the right extruder to boost your system: with a single or twin-screw design, as a mono extrusion line or co-extrusion line.

For quickly changing the screws, you can also obtain the KraussMaffei ZE twin-screw extruder in the Ultra-Glide version. Using a mechanical positioning unit, you can move the complete extruder drive laterally, and the screws can be pulled out backwards without disassembling the die or other units.

The counter-rotating 32D twin-screw series KMD is perfectly suited to extruding compact and foamed PVC sheets as well as to processing C-PVC and natural fiber-reinforced materials.

Polishing calender technology

KraussMaffei polishing calenders in various models always provide an optimum, cost-effective solution for your sheet production.

The proven technology, continuously optimized, ensures the best sheet quality with the highest throughputs and minimal maintenance costs.

YOUR ADVANTAGES:

- Narrow run-out tolerance and uniform cooling
- Tested for pressure resistance in accordance with the strict European directives
- Mechanical or self-adjusting hydraulic gap setting systems

Pioneering design engineering

Perfect polishing calenders and downstream units

The KraussMaffei polishing calenders set new standards by means of their design features, such as:

- Rigid frame and roll constructions
- Individually designed temperature control systems
- Highly accurate single drives for each roll
- Horizontal, tilted or vertical roll arrangements
- Optimum product quality thanks to perfectly coordinated downstream units

Depending on the kind and thickness of polymer, the extruded sheet or webs, having been calibrated in the polishing calender, are cooled down, laminated, trimmed, and wrapped or stacked. For windable sheets there is a wide variety of winder versions available, from the simple large-roll winder to the fully automatic turret winder.

Reliability and flexibility combined perfectly

The patented PlanetCalender is the perfect machine for manufacturing clear sheets made of the polymers such as PMMA, PC, PETG, APET, PS, SAN, or ABS with highest visual quality. With its variable positioning of rolls 1 and 3, this polishing calender combines all advantages

of the standard design – horizontal, tilted, or vertical – from a process technology standpoint.

In addition to the option of optimizing the melt infeed angle by rotating the entire frame, the cooling time of the sheet's back res. front side can be controlled. To do so, the position of roll 3 can be adjusted relative to central roll 2. Consequently, it is possible to optimize the cooling conditions for a wide variety of material types and strengths.

Another great process advantage is the change of the central roll in only 30 minutes. This reduces downtimes and creates significant savings.

Optimum product quality by means of perfectly coordinated downstream units

At KraussMaffei, all other components of the downstream equipment for the sheet systems have been designed with the future in mind. They are equipped with state-of-the-art technology, and yet are robust, reliable, and able to handle the highest throughputs.

The polishing calender is followed by an ambient cooling roller track, which automatically follows the movement of the last polishing roll in the PlanetCalender.

Depending on the task, a wide variety of auxiliary units can be integrated into the extrusion sheet system.

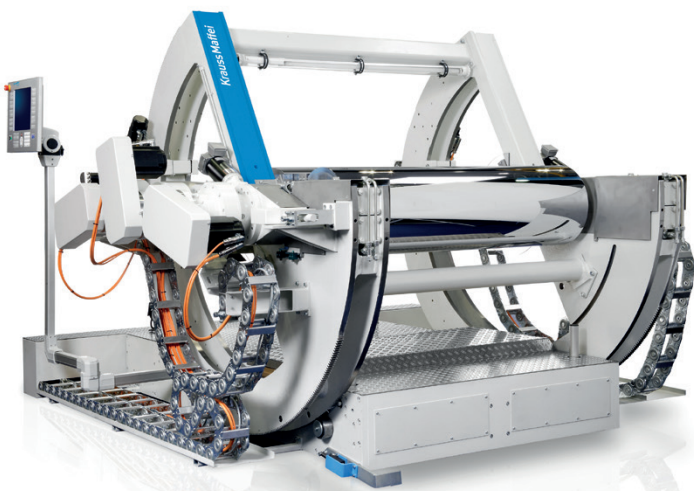

PlanetCalender – flexible polishing calender for optimum quality

YOUR ADVANTAGES:

- Reduced downtime
- Perfectly coordinated downstream units
- Highest throughput

Here we are building the future for you TechCenter

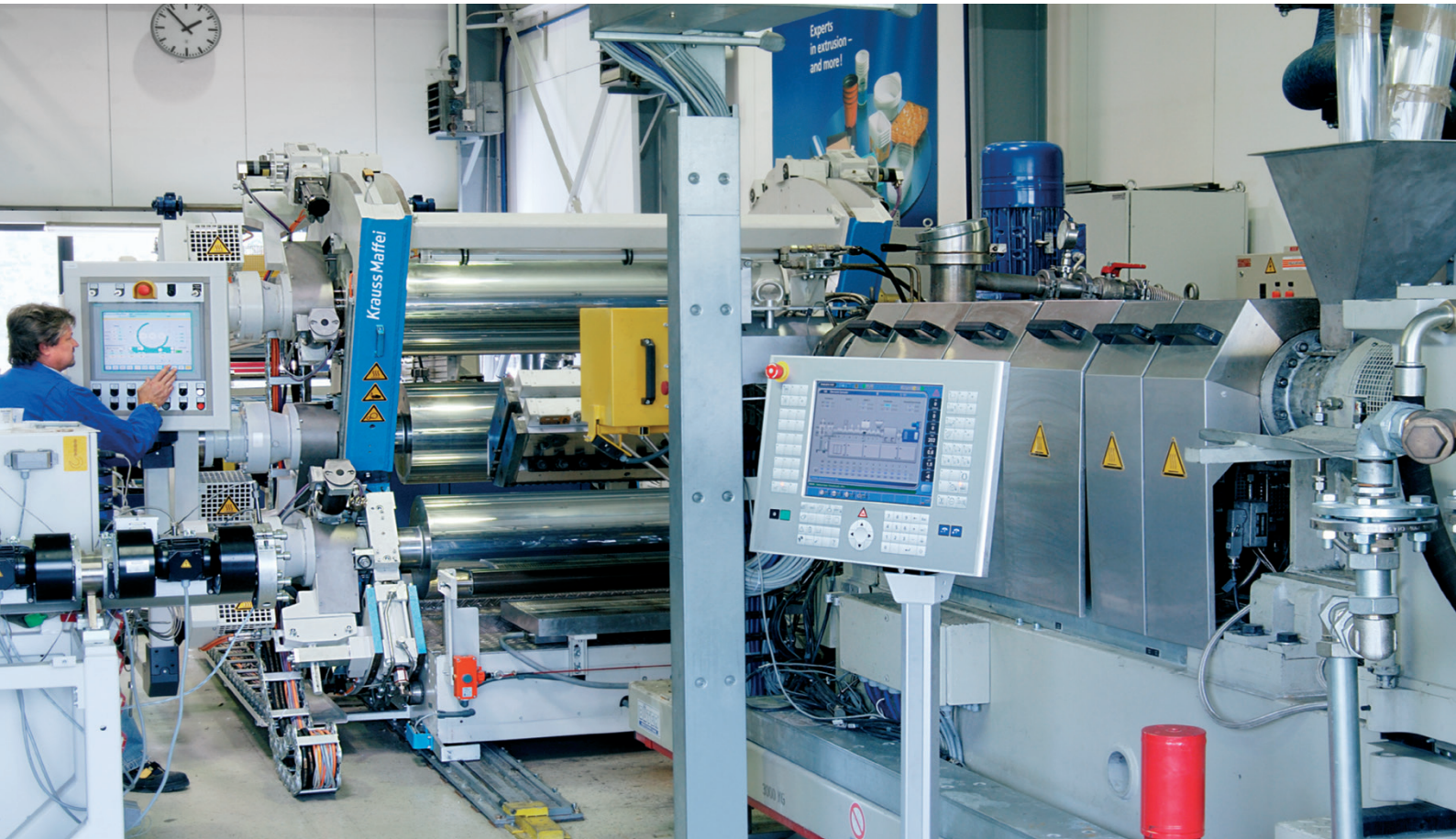

State-of-the-art equipment: the KraussMaffei TechCenter

Do you want to try out new processing problems in advance and refine individual parameters as necessary in order to achieve the best results from the beginning? Welcome to the nearest KraussMaffei TechCenter! Talk to our experts.

Testing and optimizing processes

The KraussMaffei TechCenters in Hanover, Munich, Florence (USA) and Shanghai are available for your trials. Sheets and laminates in widths up to approx. 1,100 mm can be produced.

The ideal place for optimizing your process even before you begin design engineering a new system with the support of KraussMaffei. Determine in your trials the

perfect configuration and design of all system components.

Together with our skilled team, you can test and optimize every process step, every screw geometry and every barrel configuration of the extruder and with different sheet processing conditions under realistic operating conditions and using your own material.

SHEET MANUFACTURING IN PERFECTION

HIGH-PERFORMANCE EXTRUSION LINES UP TO ANY CHALLENGE

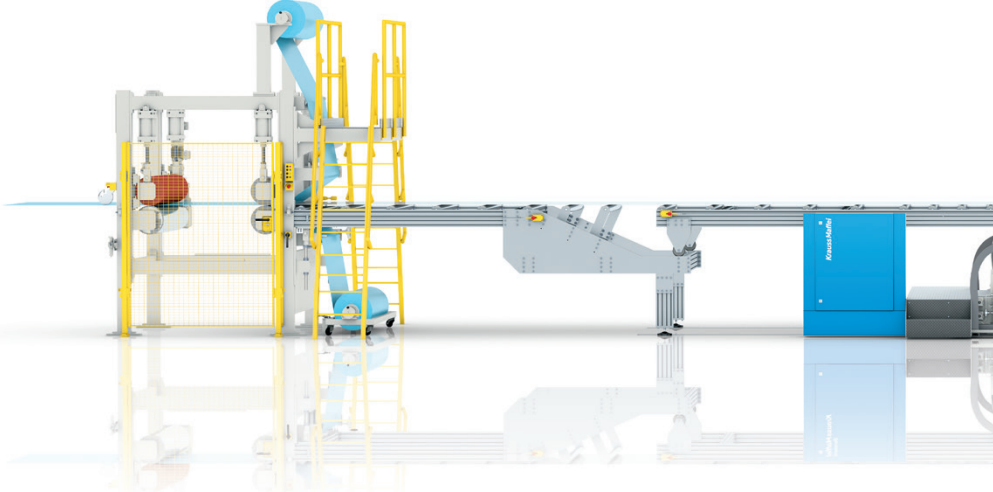

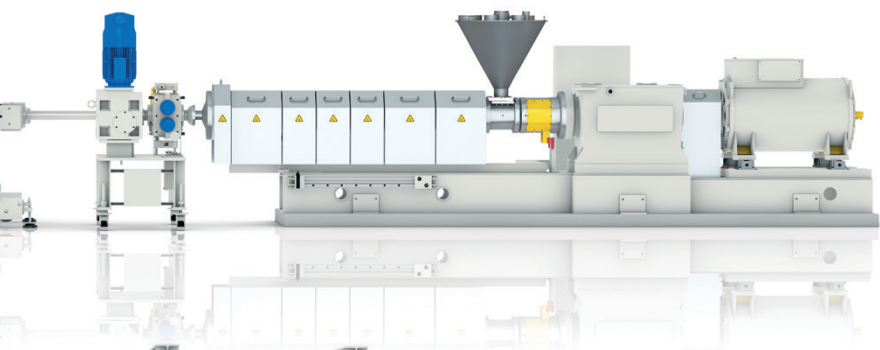

State-of-the-art sheet extrusion line for highest efficiency, reliability and maximum productivity combined with easiest operability

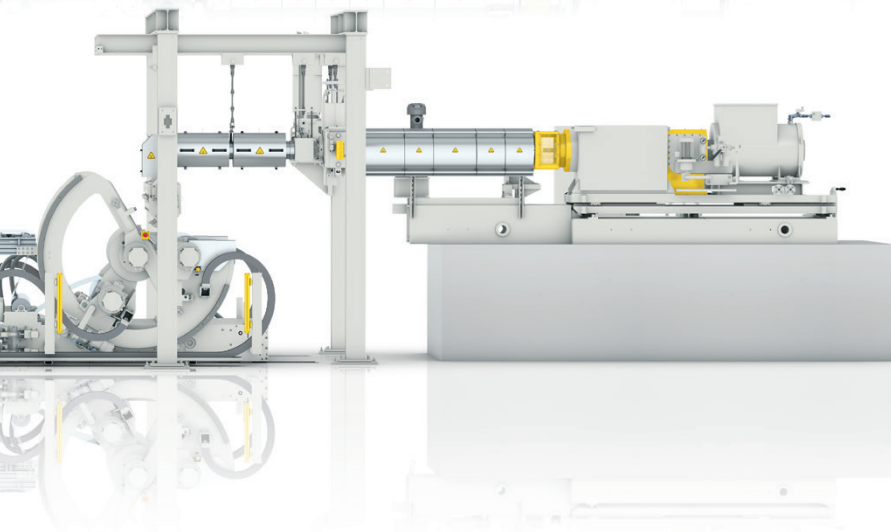

Cost-effective sheet extrusion line with in-line compounding

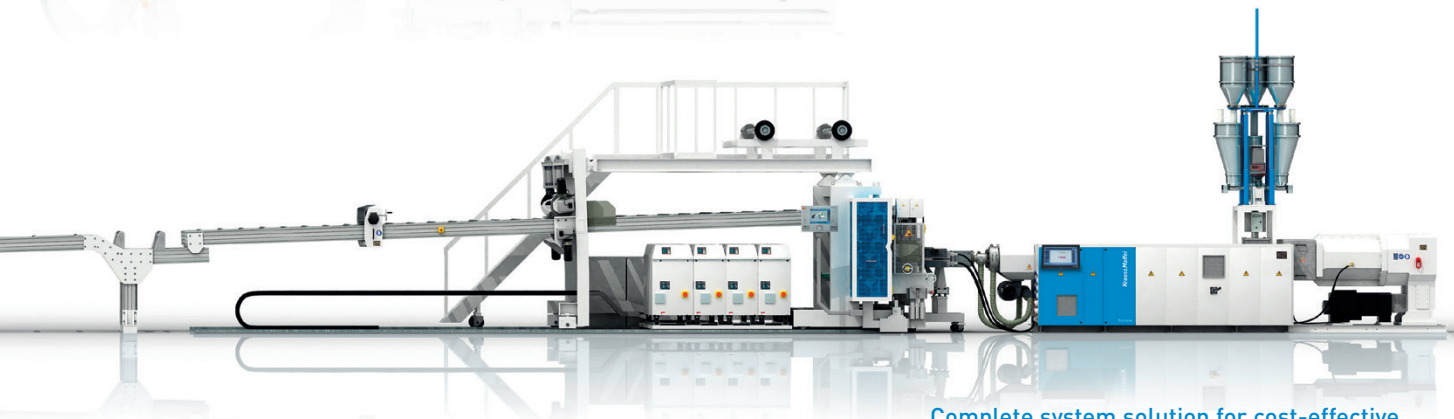

Complete system solution for cost-effective production of sheets of PVC



OUR WORLDWIDE EXPERTISE IS YOUR ADVANTAGE DIGITAL & SERVICE SOLUTIONS

With your KraussMaffei machine, you have chosen a product that delivers the highest levels of productivity and reliability. In addition to our range of machinery, KraussMaffei focuses on comprehensive and future-oriented solutions, innovative business models and an innovative portfolio of digital products.

Customer service at the touch of a button

The process of digital transformation is becoming faster and easier than ever for the customer. Our Digital & Service Solutions unit makes your production chain even more flexible and efficient with future-oriented solutions. KraussMaffei thus globally provides an all-inclusive customer service package and networks machines and processes with each other. Our global support offers a sound basis for your local long-term success.

Individual challenges in mechanical engineering call for intelligent solutions

With our services portfolio, we support you throughout your machine's lifecycle with a strong focus on your specific needs. In order to satisfy your wishes, we offer you a wide range of solutions in order to ensure maximum availability and optimum productivity of your machines.

Technology³ as a unique selling proposition

KraussMaffei is the only supplier in the world with a product range comprising the most important machine technologies for plastic and rubber processing: injection molding machinery, automation, reaction process machinery and extrusion technology. KraussMaffei is represented worldwide with more than 30 subsidiaries and over 10 production plants as well as about 570 commercial and service partners. Working together with our customers and partners, we are thus in a position to offer vast and unique expertise in the industry.

You can find further information at:
www.kraussmaffei.com





KRAUSSMAFFEI –
PIONEERING PLASTICS



Extensive expertise from a single supplier

KraussMaffei is one of the world's leading manufacturers of machinery and systems for producing and processing plastics and rubber. Our brand has been synonymous with cutting-edge technology for over 180 years. Our product range includes all technologies in injection molding, extrusion and reaction process machinery. KraussMaffei has a unique selling proposition in the industry as a result. By drawing on our proven innovative capacity, we can guarantee our customers sustained additional value over their entire value-adding chain through our standardized and individual product, process, digital and service solutions. The range of our products and services allows us to serve customers in

many sectors including the automotive, packaging, medical and construction industries. We also supply manufacturers of electrical and electronic products and household appliances.

At your service all over the world

KraussMaffei is represented all over the world. Subsidiaries provide you with support in the countries shown in light blue. Our sales and service partners take care of you in the regions shown in white.

You can find all contact information at
www.kraussmaffei.com

MAXIMUM PRODUCT QUALITY AND PRODUCTION RELIABILITY.

DISCOVER OUR SHEET EXTRUSION
LINES.



kraussmaffe.com